

TDG 1490

FITTING INSTRUCTION / INSTRUCTION DE MONTAGE / EINBAUANLEITUNG /
ISTRUZIONI PER L'USO / INSTRUCCIONES DE MONTAJE / MONTAGEHANDLEIDING



FORD S-MAX

DOG GUARD / GRILLE PROTECTRICE POUR CHIEN / HUNDEGITTER /
RIPARO PER CANI / DEFENSA PARA PERROS / HONDEREK

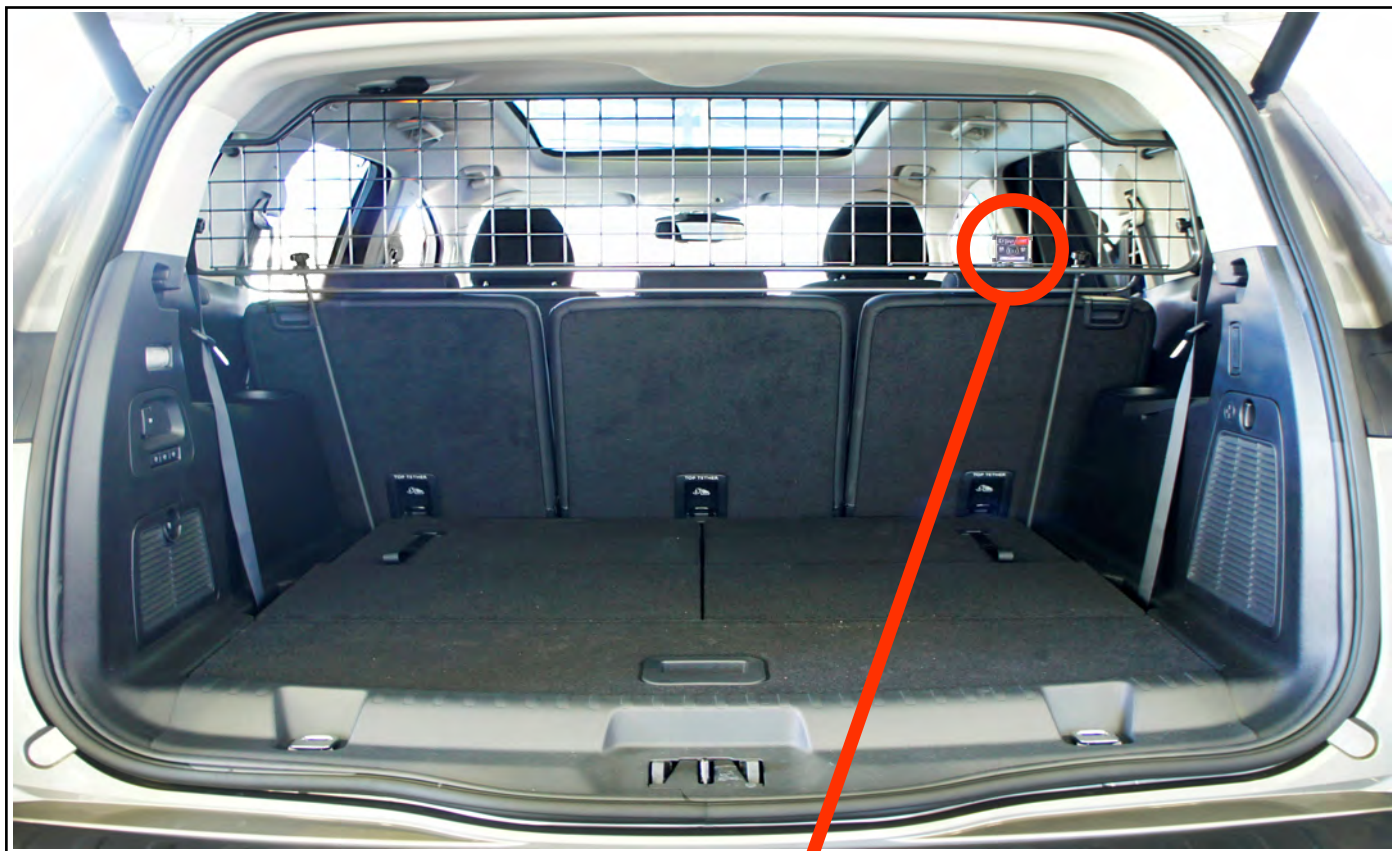

- E Mark Badge must be visible from the luggage area of the vehicle.
Le badge de la marque E doit être visible depuis le coffre à bagages du véhicule.
Il contrassegno E deve essere visibile dal vano bagagli del veicolo.
El distintivo de la marca E debe ser visible desde el maletero del vehículo.
- Das E-Prüfzeichen muss vom Gepäckraum des Fahrzeugs aus sichtbar sein.

TDG 1490

FITTING INSTRUCTION / INSTRUCTION DE MONTAGE / EINBAUANLEITUNG /
ISTRUZIONI PER L'USO / INSTRUCCIONES DE MONTAJE / MONTAGEHANDLEIDING



FORD S-MAX

DOG GUARD / GRILLE PROTECTRICE POUR CHIEN / HUNDEGITTER /
RIPARO PER CANI / DEFENSA PARA PERROS / HONDEREK

- This product is suitable for installation and use only in the vehicle stated.
 - Please ensure you correctly follow the installation method described in this document on every use.
- GB**
- We recommend you do not stack objects higher than the top of the seat in the luggage area and where possible secured using appropriate restraint systems.
 - It is important to use this partitioning system when transporting objects in the luggage area.
 - If this partitioning system is damaged in any way, it should be replaced.

- Ce produit convient uniquement à l'installation et à l'utilisation dans le véhicule indiqué.
 - Veillez à suivre correctement la méthode d'installation décrite dans ce document à chaque utilisation.
- F**
- Nous vous recommandons de ne pas empiler d'objets plus hauts que le haut du siège dans le compartiment à bagages et, dans la mesure du possible, de les fixer à l'aide de systèmes de retenue appropriés.
 - Il est important d'utiliser le système de cloisonnement lorsque vous transportez des objets dans le coffre à bagages.
 - Si le système de séparation est endommagé de quelque manière que ce soit, il doit être remplacé.

- Questo prodotto è adatto all'installazione e all'uso solo nel veicolo indicato.
 - Assicurarsi di seguire correttamente il metodo di installazione descritto in questo documento ad ogni utilizzo.
- IT**
- Si raccomanda di non impilare oggetti più alti della parte superiore del sedile nel vano bagagli e, se possibile, di fissarli con sistemi di ritenuta adeguati.
 - È importante utilizzare il sistema divisorio quando si trasportano oggetti nel bagagliaio.
 - Se il sistema divisorio è danneggiato in qualche modo, deve essere sostituito.

- Este producto es apto para su instalación y uso únicamente en el vehículo indicado.
 - Asegúrese de seguir correctamente el método de instalación descrito en este documento en cada uso.
- ES**
- Le recomendamos que no apile objetos más altos que la parte superior del asiento en el maletero y siempre que sea posible asegurarlos mediante sistemas de retención adecuados.
 - Es importante utilizar el sistema de separación al transportar objetos en el maletero.
 - Si el sistema de separación está dañado de algún modo, debe sustituirse.

- Dieses Produkt ist nur für den Einbau und die Verwendung in dem angegebenen Fahrzeug geeignet.
 - Stellen Sie sicher, dass Sie die in diesem Dokument beschriebene Einbaumethode bei jeder Verwendung korrekt befolgen.
- D**
- Wir empfehlen Ihnen, im Gepäckraum keine Gegenstände zu stapeln, die höher als die Oberkante des Sitzes sind und wenn möglich mit geeigneten Rückhaltesystemen zu sichern.
 - Es ist wichtig, das Trennwandsystem zu verwenden, wenn Sie Gegenstände im Gepäckraum transportieren.
 - Wenn das Trennwandsystem in irgendeiner Weise beschädigt ist, muss es ersetzt werden.

TDG 1490

FITTING INSTRUCTION / INSTRUCTION DE MONTAGE / EINBAUANLEITUNG /
ISTRUZIONI PER L'USO / INSTRUCCIONES DE MONTAJE / MONTAGEHANDLEIDING



FORD S-MAX

DOG GUARD / GRILLE PROTECTRICE POUR CHIEN / HUNDEGITTER /
RIPARO PER CANI / DEFENSA PARA PERROS / HONDEREK

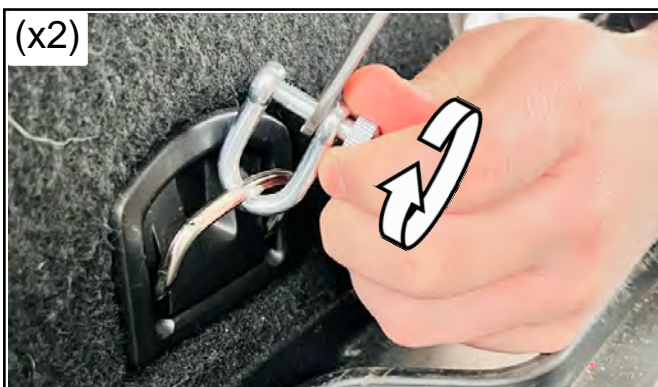
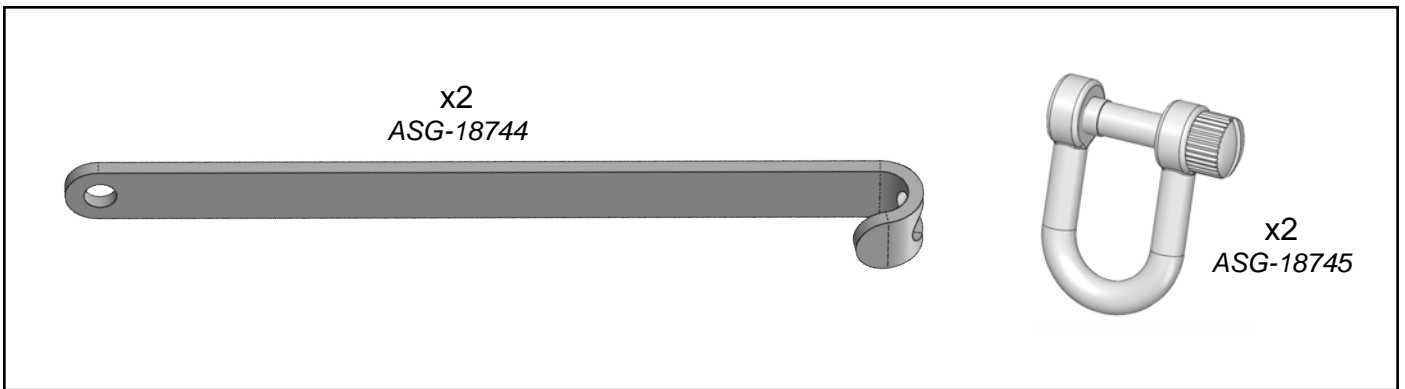
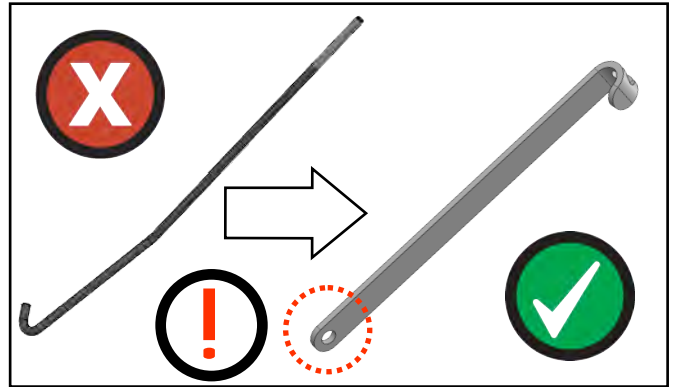

TDG 1490

FITTING INSTRUCTION / INSTRUCTION DE MONTAGE / EINBAUANLEITUNG /
ISTRUZIONI PER L'USO / INSTRUCCIONES DE MONTAJE / MONTAGEHANDLEIDING



FORD S-MAX

DOG GUARD / GRILLE PROTECTRICE POUR CHIEN / HUNDEGITTER /
RIPARO PER CANI / DEFENSA PARA PERROS / HONDEREK

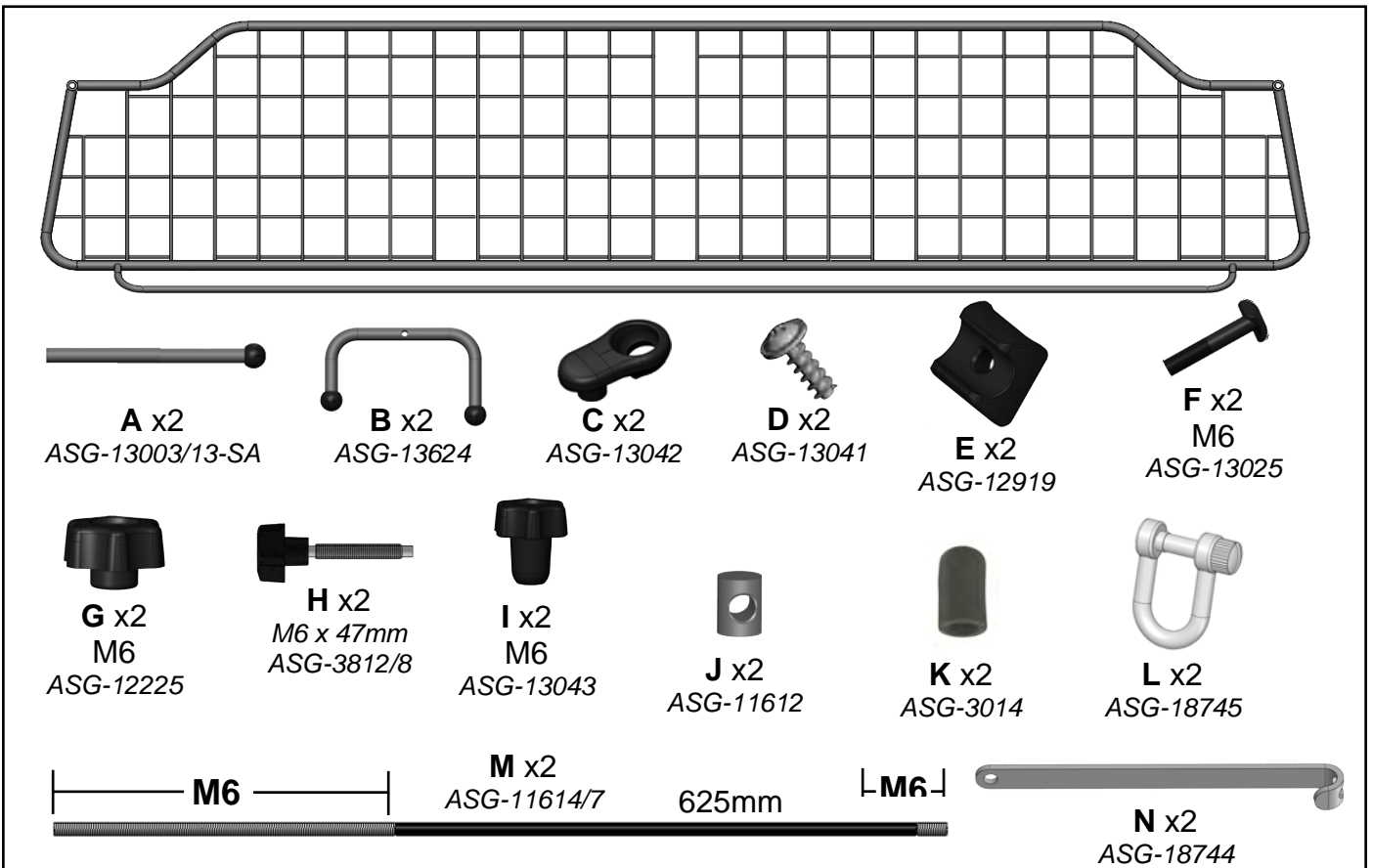

TDG 1490

FITTING INSTRUCTION / INSTRUCTION DE MONTAGE / EINBAUANLEITUNG /
ISTRUZIONI PER L'USO / INSTRUCCIONES DE MONTAJE / MONTAGEHANDLEIDING



FORD S-MAX

DOG GUARD / GRILLE PROTECTRICE POUR CHIEN / HUNDEGITTER /
RIPARO PER CANI / DEFENSA PARA PERROS / HONDEREK

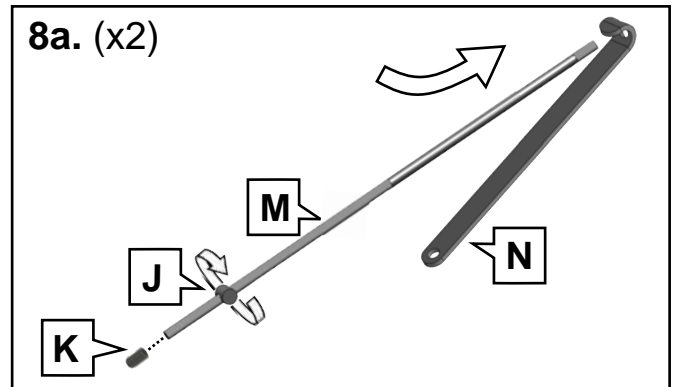
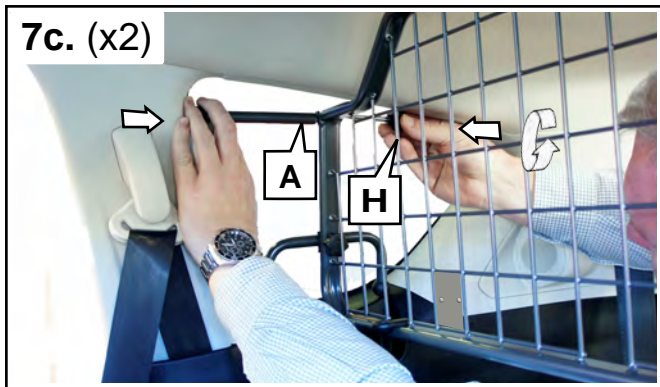
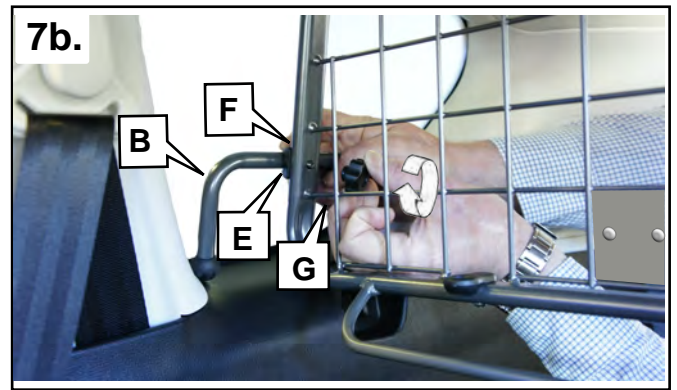
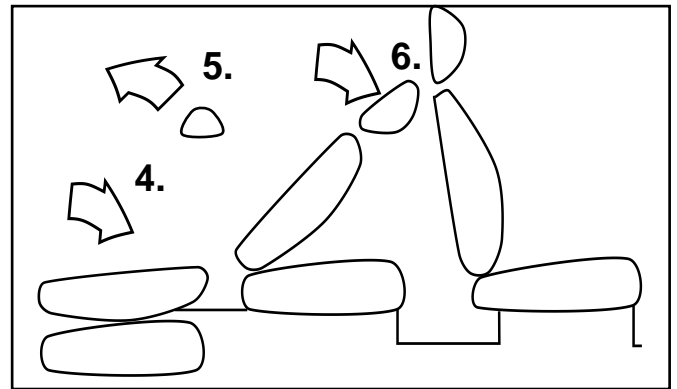
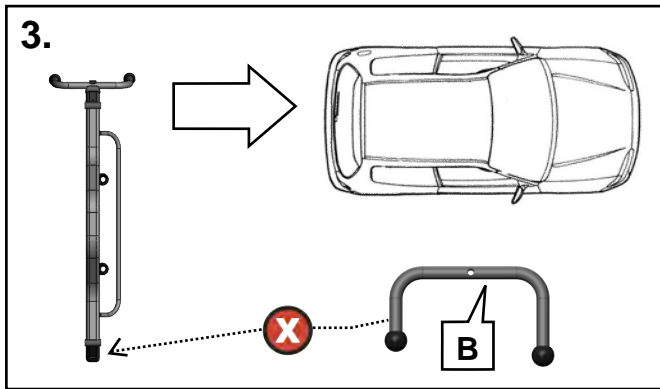
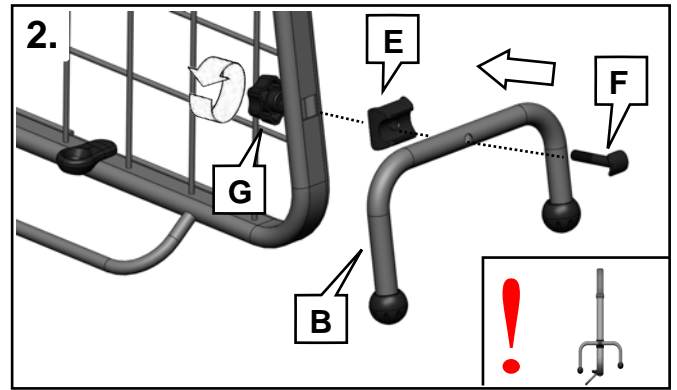
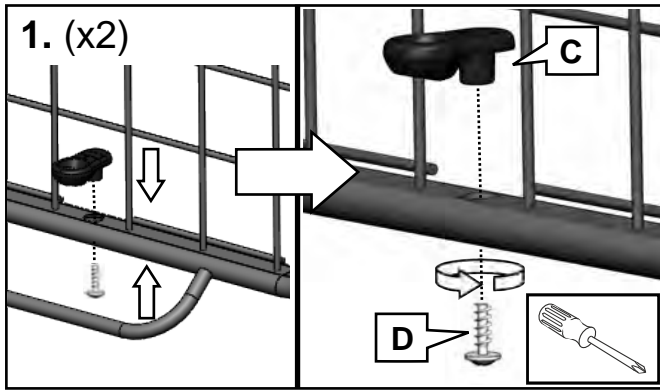

TDG 1490

FITTING INSTRUCTION / INSTRUCTION DE MONTAGE / EINBAUANLEITUNG /
ISTRUZIONI PER L'USO / INSTRUCCIONES DE MONTAJE / MONTAGEHANDLEIDING



FORD S-MAX

DOG GUARD / GRILLE PROTECTRICE POUR CHIEN / HUNDEGITTER /
RIPARO PER CANI / DEFENSA PARA PERROS / HONDEREK

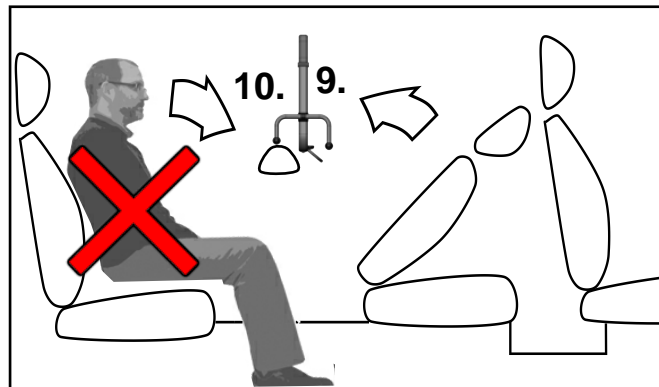
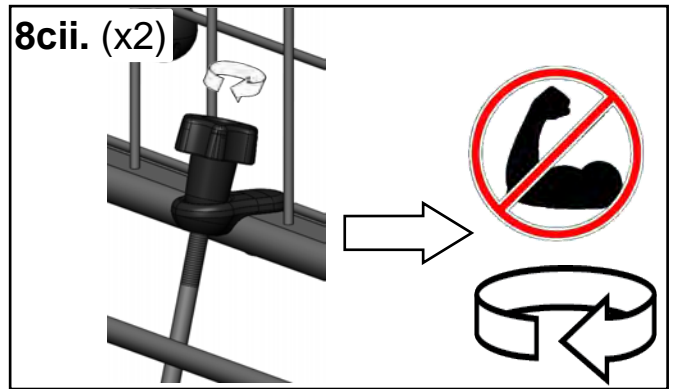
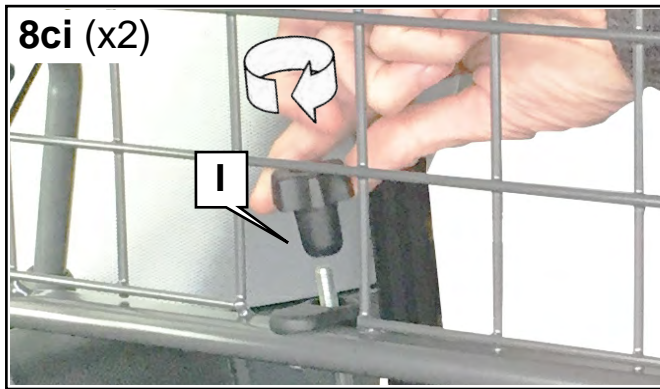
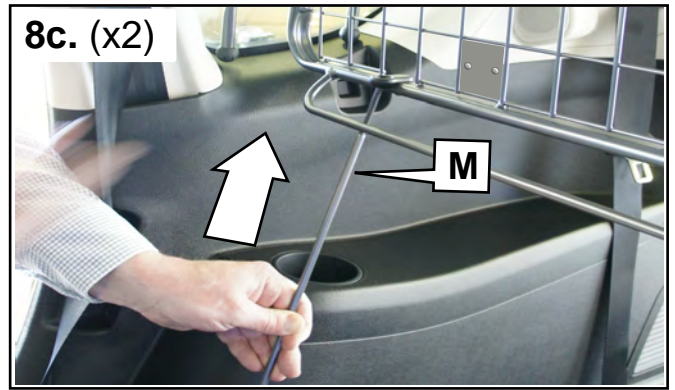
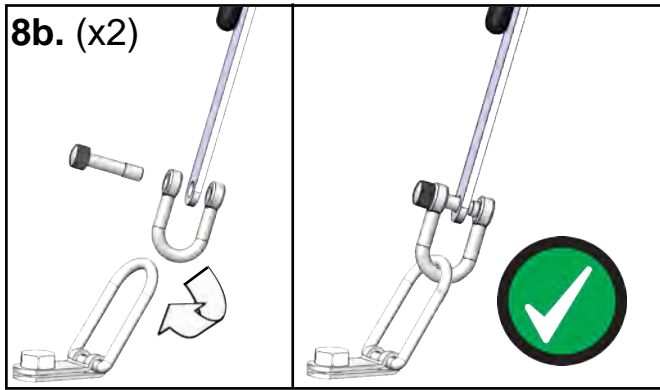

TDG 1490

FITTING INSTRUCTION / INSTRUCTION DE MONTAGE / EINBAUANLEITUNG /
ISTRUZIONI PER L'USO / INSTRUCCIONES DE MONTAJE / MONTAGEHANDLEIDING



FORD S-MAX

DOG GUARD / GRILLE PROTECTRICE POUR CHIEN / HUNDEGITTER /
RIPARO PER CANI / DEFENSA PARA PERROS / HONDEREK

