

# TDG 1668

FITTING INSTRUCTION / INSTRUCTION DE MONTAGE / EINBAUANLEITUNG /  
ISTRUZIONI PER L'USO / INSTRUCCIONES DE MONTAJE / MONTAGEHANDLEIDUNG



## MERCEDES GLB

DOG GUARD / GRILLE PROTECTRICE POUR CHIEN / HUNDEGITTER /  
RIPARO PER CANI / DEFENSA PARA PERROS / HONDEREK

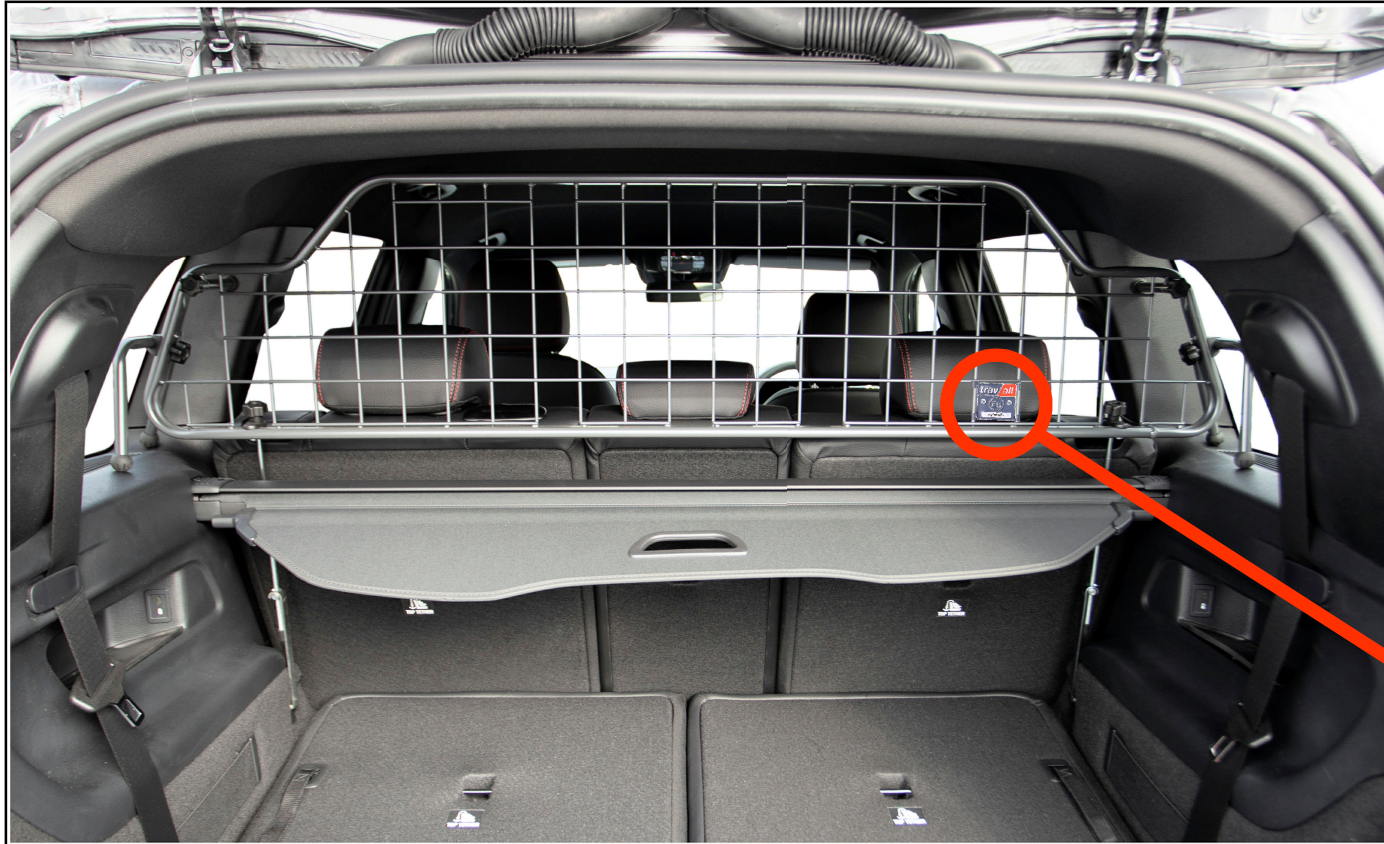

- E Mark Badge must be visible from the luggage area of the vehicle.  
Le badge de la marque E doit être visible depuis le coffre à bagages du véhicule.  
Il contrassegno E deve essere visibile dal vano bagagli del veicolo.  
El distintivo de la marca E debe ser visible desde el maletero del vehículo.  
Das E-Prüfzeichen muss vom Gepäckraum des Fahrzeugs aus sichtbar sein.

PATENTS APPLIED FOR

## MERCEDES GLB

DOG GUARD / GRILLE PROTECTRICE POUR CHIEN / HUNDEGITTER /  
RIPARO PER CANI / DEFENSA PARA PERROS / HONDEREK

**GB**

- This product is suitable for installation and use only in the vehicle stated.
- Please ensure you correctly follow the installation method described in this document on every use.
- We recommend you do not stack objects higher than the top of the seat in the luggage area and where possible secured using appropriate restraint systems.
- It is important to use this partitioning system when transporting objects in the luggage area.
- If this partitioning system is damaged in any way, it should be replaced.

**F**

- Ce produit convient uniquement à l'installation et à l'utilisation dans le véhicule indiqué.
- Veuillez à suivre correctement la méthode d'installation décrite dans ce document à chaque utilisation.
- Nous vous recommandons de ne pas empiler d'objets plus hauts que le haut du siège dans le compartiment à bagages et, dans la mesure du possible, de les fixer à l'aide de systèmes de retenue appropriés.
- Il est important d'utiliser le système de cloisonnement lorsque vous transportez des objets dans le coffre à bagages.
- Si le système de séparation est endommagé de quelque manière que ce soit, il doit être remplacé.

**IT**

- Questo prodotto è adatto all'installazione e all'uso solo nel veicolo indicato.
- Assicurarsi di seguire correttamente il metodo di installazione descritto in questo documento ad ogni utilizzo.
- Si raccomanda di non impilare oggetti più alti della parte superiore del sedile nel vano bagagli e, se possibile, di fissarli con sistemi di ritenuta adeguati.
- È importante utilizzare il sistema divisorio quando si trasportano oggetti nel bagagliaio.
- Se il sistema divisorio è danneggiato in qualche modo, deve essere sostituito.

**ES**

- Este producto es apto para su instalación y uso únicamente en el vehículo indicado.
- Asegúrese de seguir correctamente el método de instalación descrito en este documento en cada uso.
- Le recomendamos que no apile objetos más altos que la parte superior del asiento en el maletero y siempre que sea posible asegurarlos mediante sistemas de retención adecuados.
- Es importante utilizar el sistema de separación al transportar objetos en el maletero.
- Si el sistema de separación está dañado de algún modo, debe sustituirse.

**D**

- Dieses Produkt ist nur für den Einbau und die Verwendung in dem angegebenen Fahrzeug geeignet.
- Stellen Sie sicher, dass Sie die in diesem Dokument beschriebene Einbaumethode bei jeder Verwendung korrekt befolgen.
- Wir empfehlen Ihnen, im Gepäckraum keine Gegenstände zu stapeln, die höher als die Oberkante des Sitzes sind und wenn möglich mit geeigneten Rückhaltesystemen zu sichern.
- Es ist wichtig, das Trennwandsystem zu verwenden, wenn Sie Gegenstände im Gepäckraum transportieren.
- Wenn das Trennwandsystem in irgendeiner Weise beschädigt ist, muss es ersetzt werden.



# TDG 1668

FITTING INSTRUCTION / INSTRUCTION DE MONTAGE / EINBAUANLEITUNG /  
ISTRUZIONI PER L'USO / INSTRUCCIONES DE MONTAJE / MONTAGEHANDLEIDING



## MERCEDES GLB

DOG GUARD / GRILLE PROTECTRICE POUR CHIEN / HUNDEGITTER /  
RIPARO PER CANI / DEFENSA PARA PERROS / HONDEREK

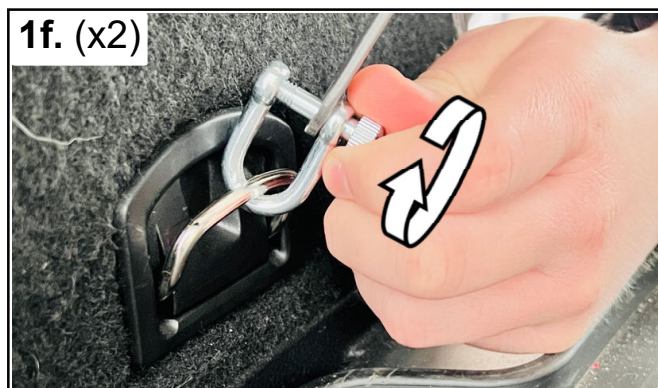
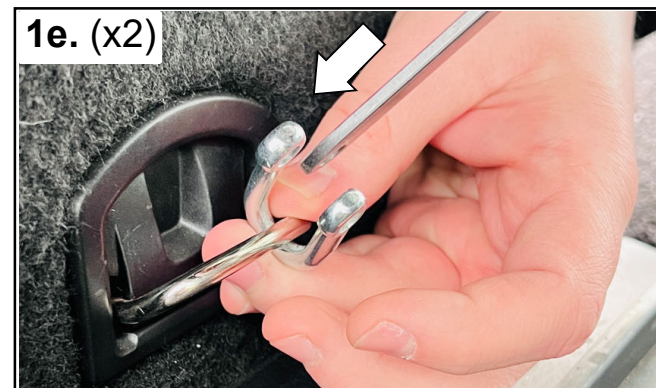
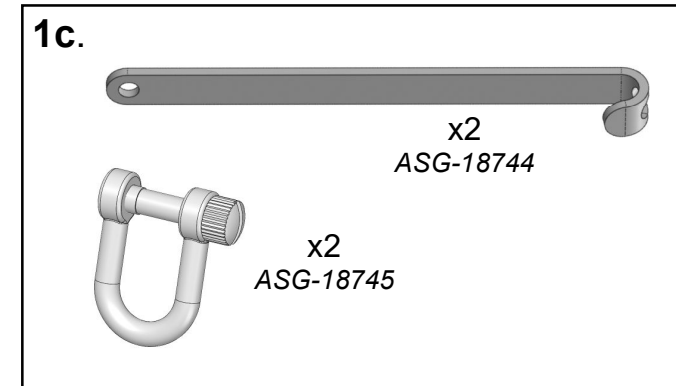
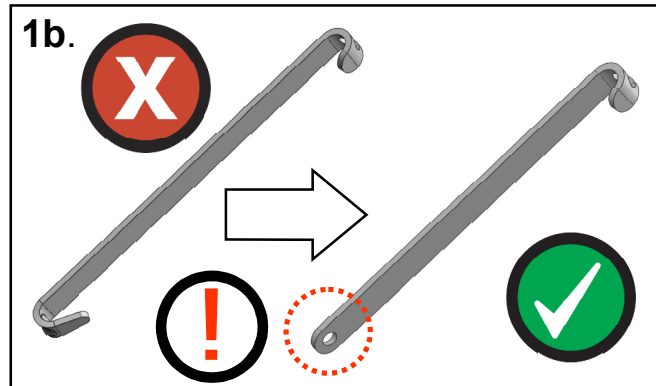

# TDG 1668

FITTING INSTRUCTION / INSTRUCTION DE MONTAGE / EINBAUANLEITUNG /  
ISTRUZIONI PER L'USO / INSTRUCCIONES DE MONTAJE / MONTAGEHANDLEIDING



## MERCEDES GLB

DOG GUARD / GRILLE PROTECTRICE POUR CHIEN / HUNDEGITTER /  
RIPARO PER CANI / DEFENSA PARA PERROS / HONDEREK

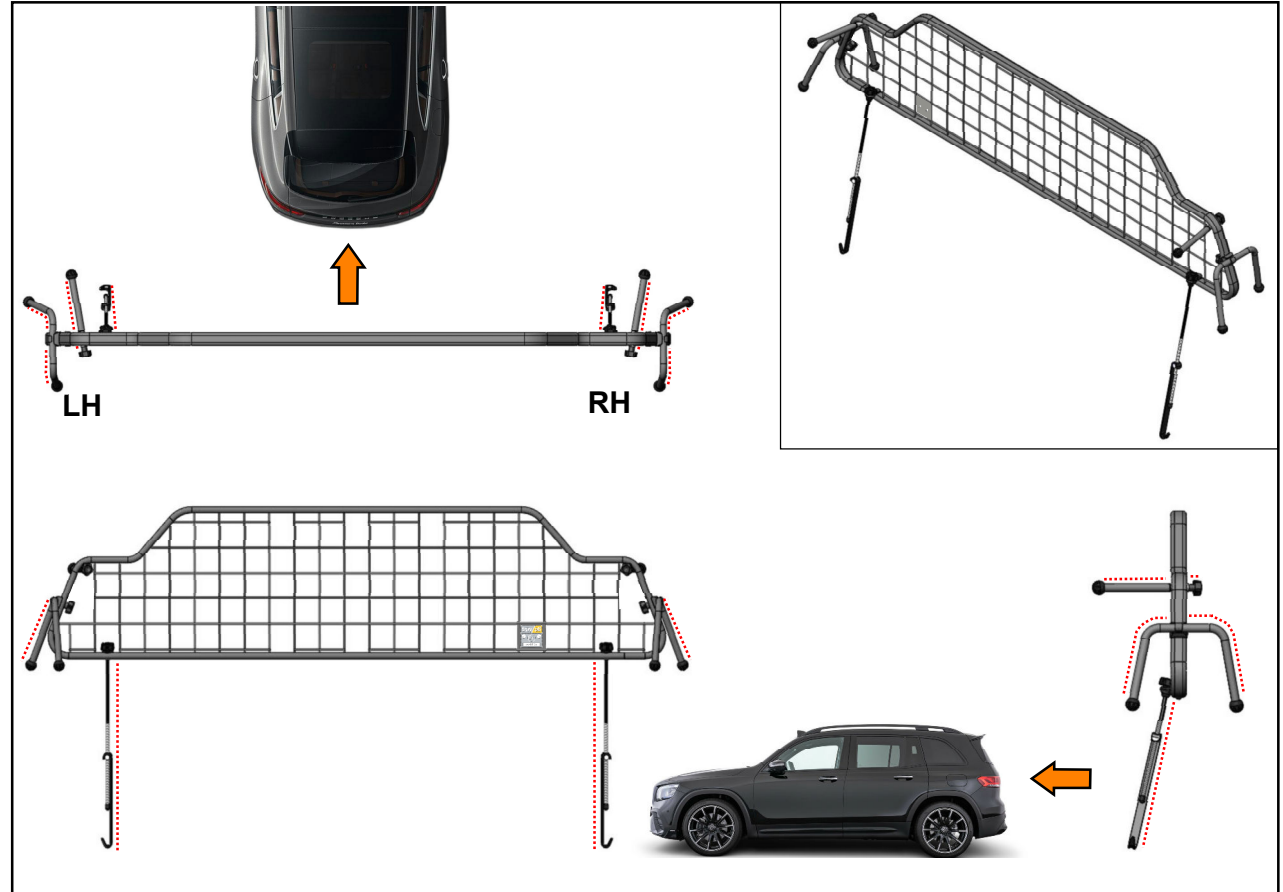

### TRAVALL

The contents and parts shown in this fitting instruction is the property of TRAVALL therefore anything shown should not be used for any other manufacturing purposes, copied or replicated in any way without written authorisation from ©TRAVALL.

TRAVALL UNITED KINGDOM  
GOSFORTH ROAD,  
DERBY,  
DE24 8HU,  
United Kingdom,  
E: [Info@travall.com](mailto:Info@travall.com)  
T: +44(0)1332387630

### The Travall Difference

Lifetime Warranty • OEM Car Factory Supplier  
100s of Applications • Manufacturer for Over 30 Years



PATENTS APPLIED FOR



# TDG 1668

FITTING INSTRUCTION / INSTRUCTION DE MONTAGE / EINBAUANLEITUNG /  
ISTRUZIONI PER L'USO / INSTRUCCIONES DE MONTAJE / MONTAGEHANDLEIDUNG



## MERCEDES GLB

DOG GUARD / GRILLE PROTECTRICE POUR CHIEN / HUNDEGITTER /  
RIPARO PER CANI / DEFENSA PARA PERROS / HONDEREK

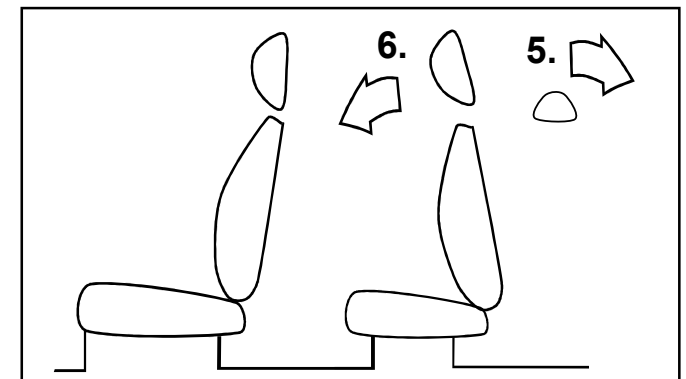
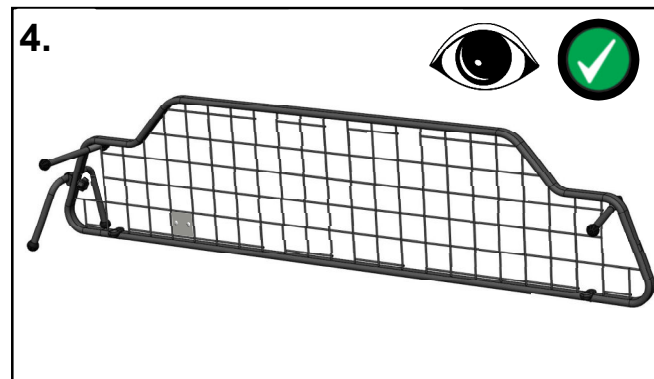
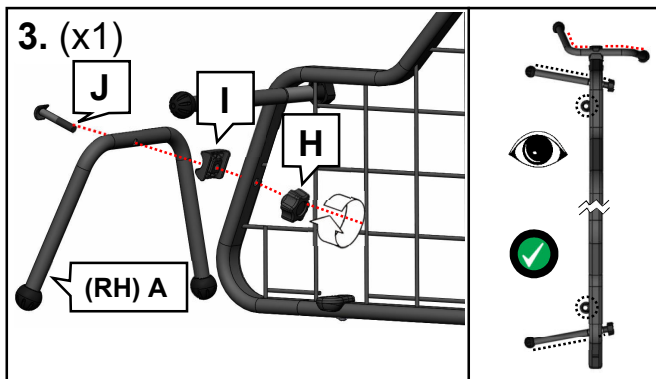
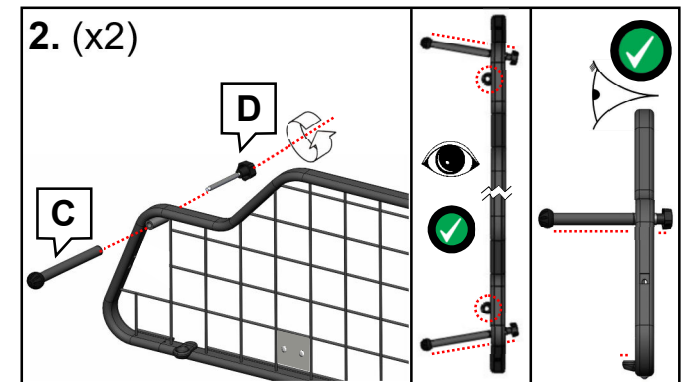
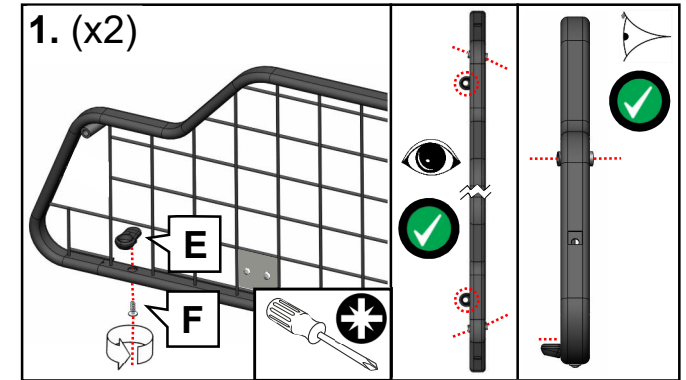
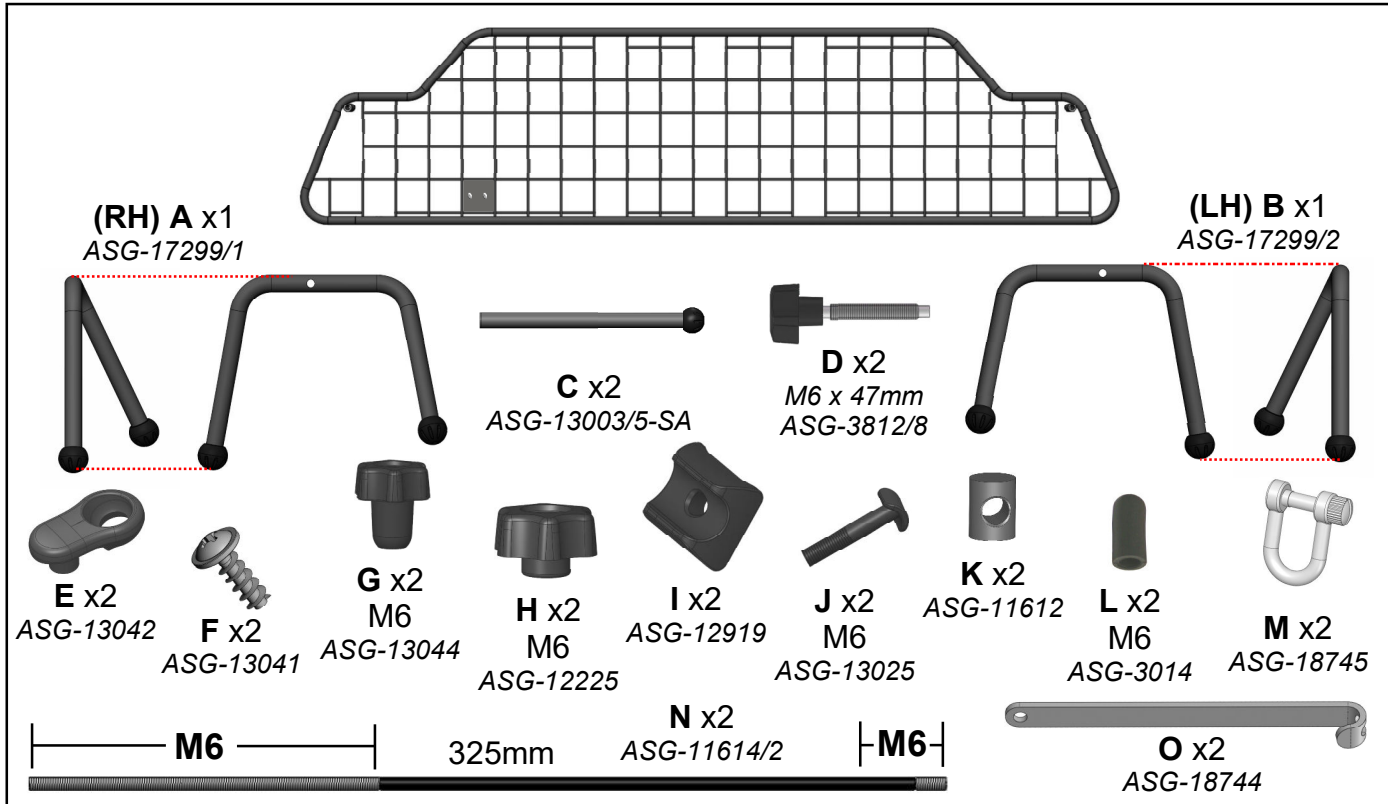

# TDG 1668

FITTING INSTRUCTION / INSTRUCTION DE MONTAGE / EINBAUANLEITUNG /  
ISTRUZIONI PER L'USO / INSTRUCCIONES DE MONTAJE / MONTAGEHANDLEIDUNG



## MERCEDES GLB

DOG GUARD / GRILLE PROTECTRICE POUR CHIEN / HUNDEGITTER /  
RIPARO PER CANI / DEFENSA PARA PERROS / HONDEREK

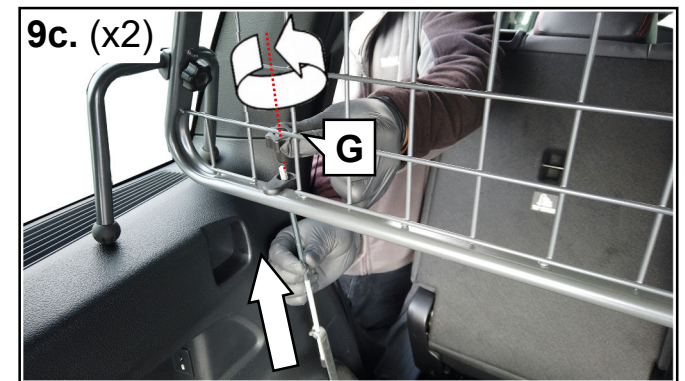
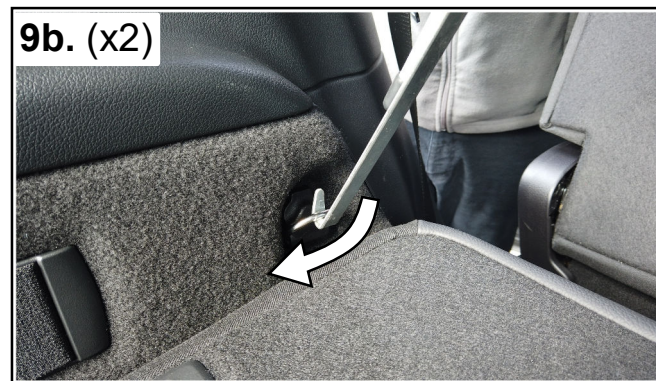
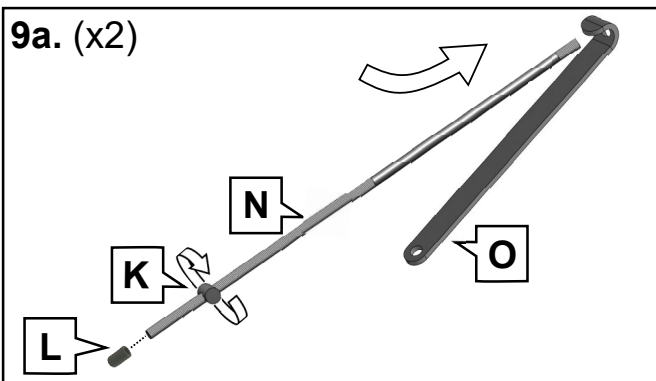
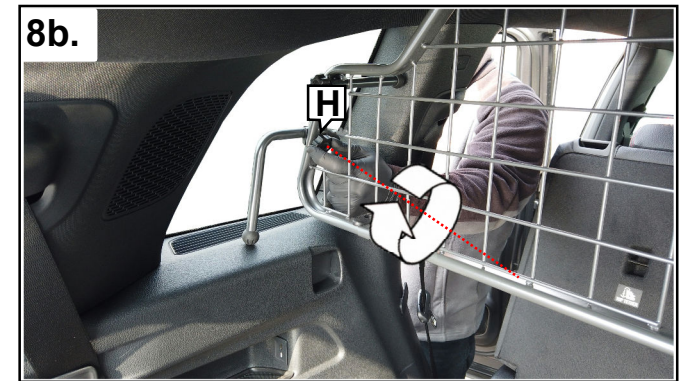
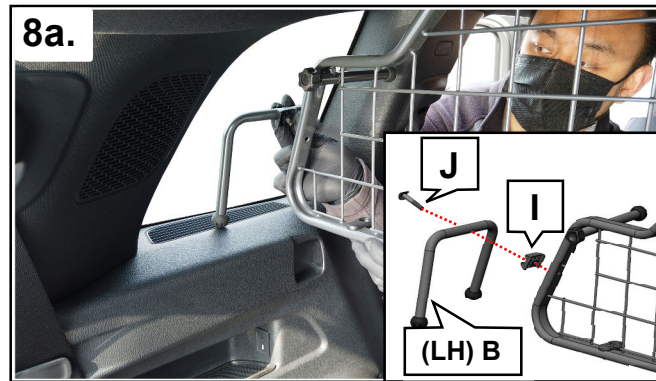
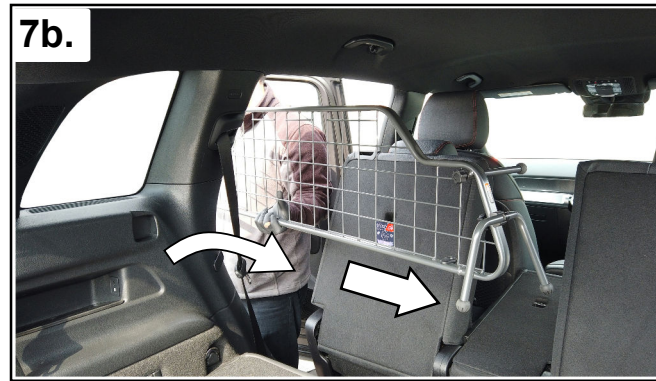
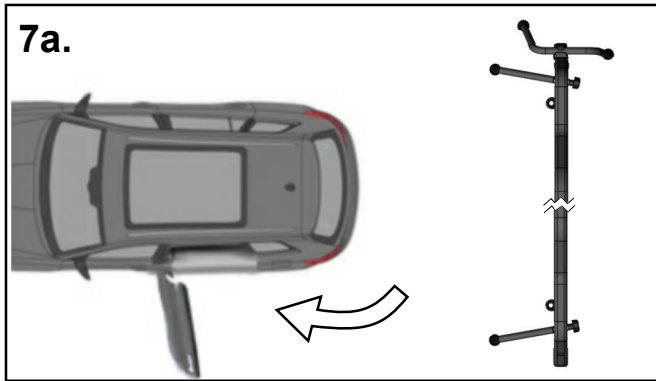

PATENTS APPLIED FOR



## MERCEDES GLB

DOG GUARD / GRILLE PROTECTRICE POUR CHIEN / HUNDEGITTER /  
RIPARO PER CANI / DEFENSA PARA PERROS / HONDEREK

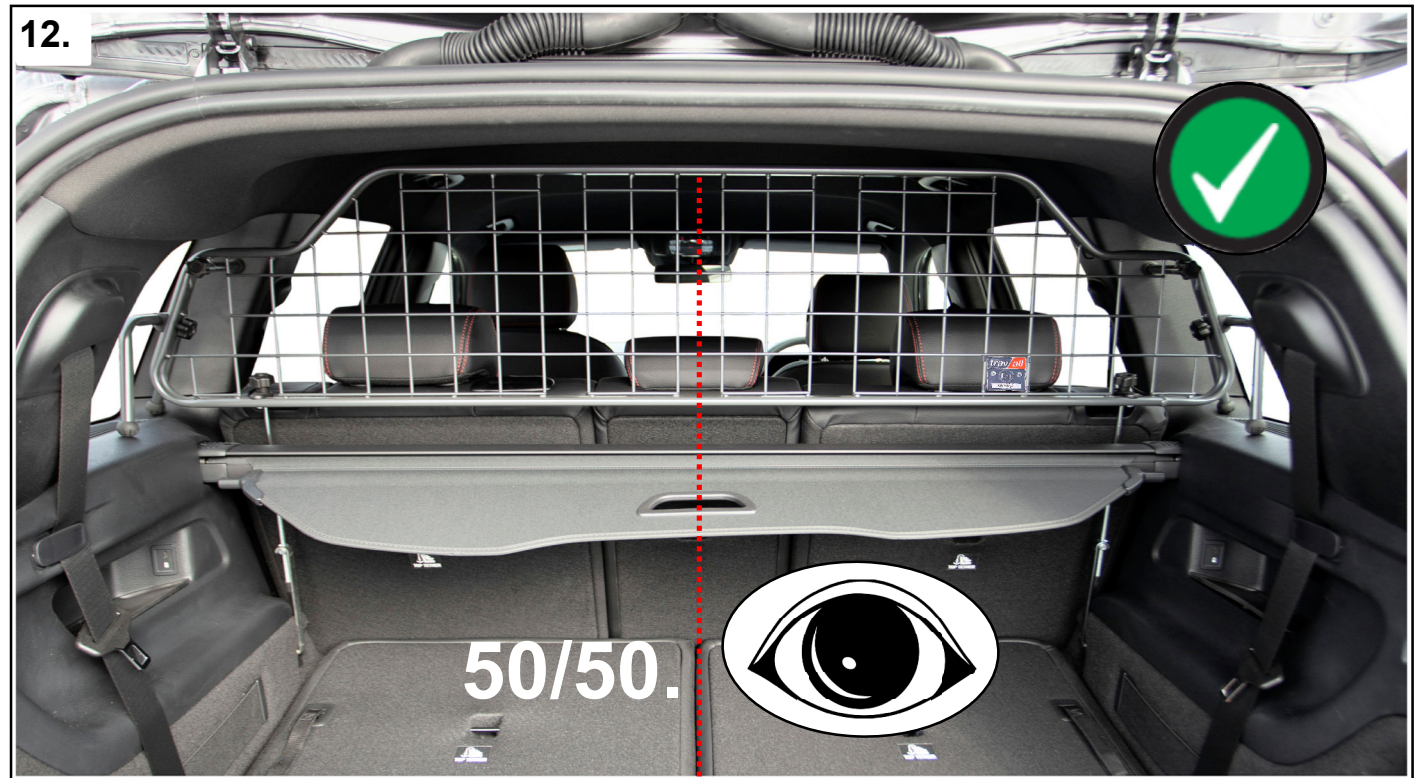
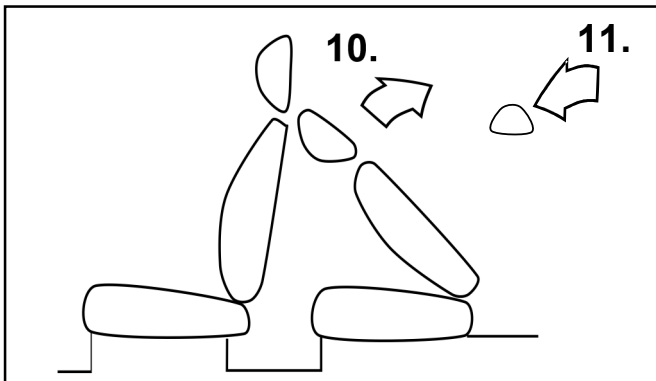
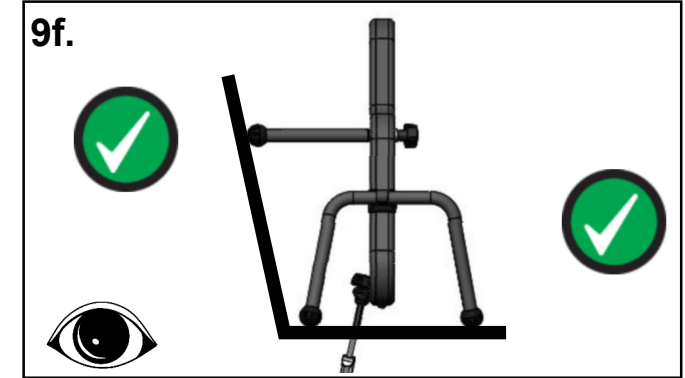
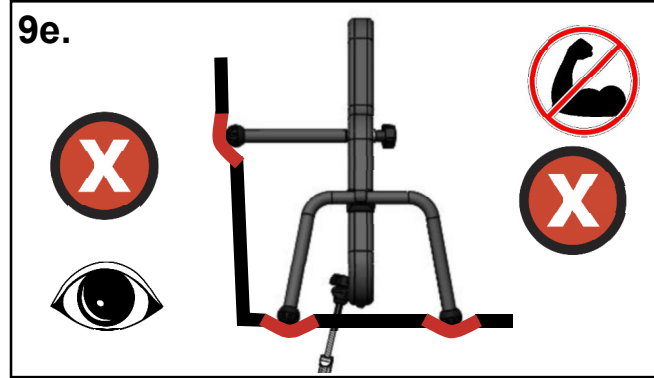
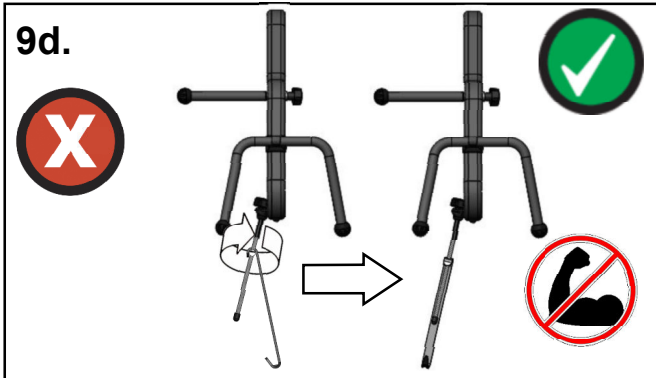

50/50.